

# NEXO PS15

TOP

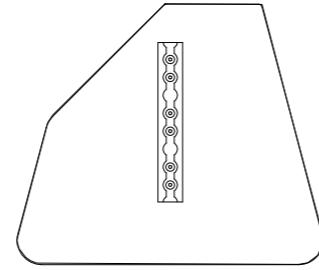

LEFT

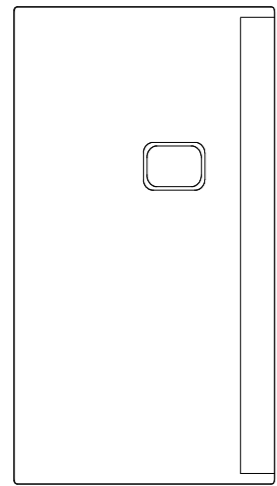

369

FRONT

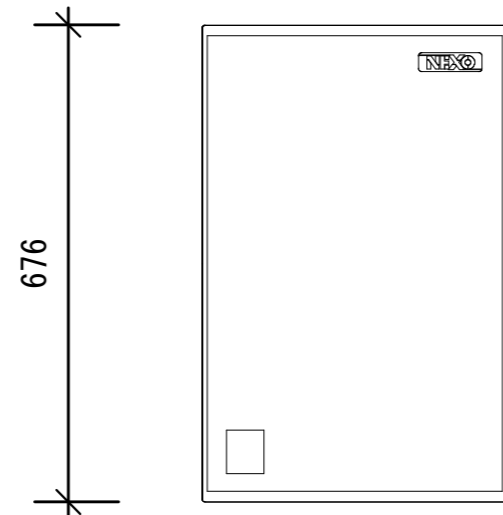

676

434

BOTTOM

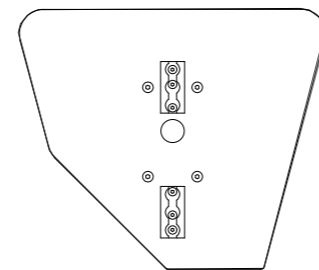

RIGHT

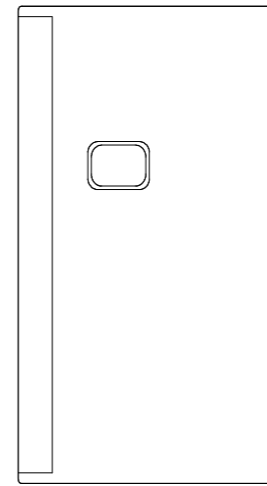

REAR

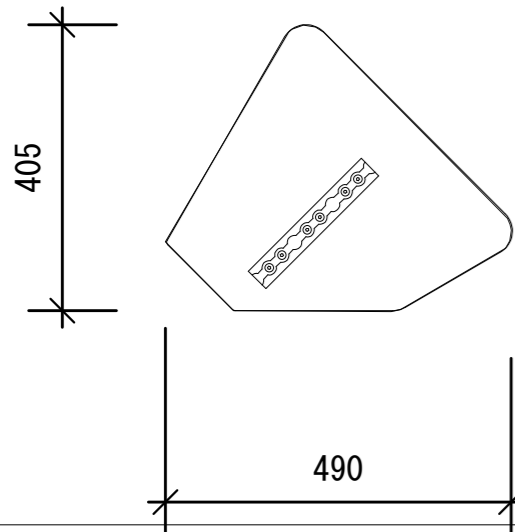
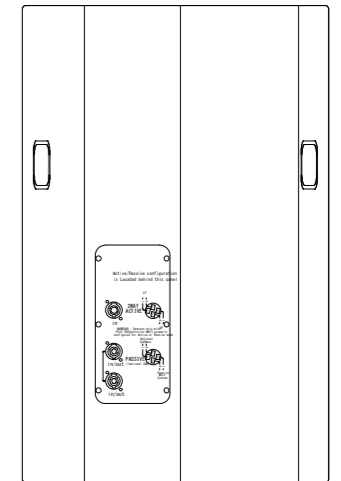

**FREQUENCY:** 50Hz-18kHz  
**MAX SPL:** 134dB  
**COVERAGE:** 100° \*55°  
**CONNECTOR:** NL4\*2  
**WIDE:** 434mm  
**HEIGHT:** 676mm  
**DEPTH:** 369mm  
**WEIGHT:** 30.5kg